

## DRAWER TRACK SETS

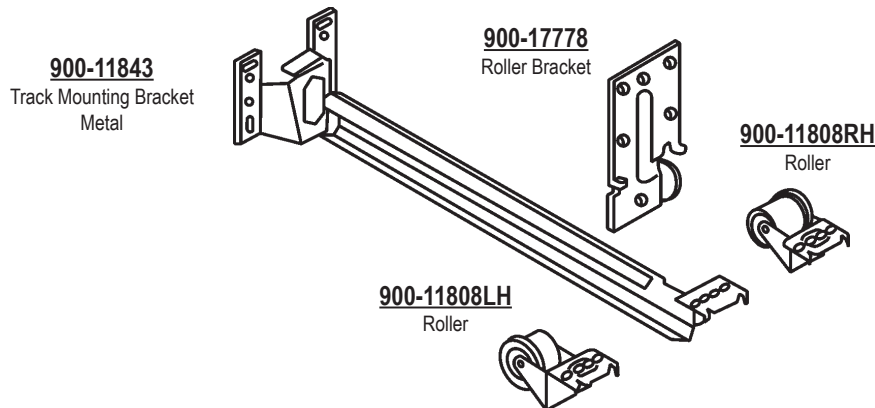

## DRAWER INSERTS

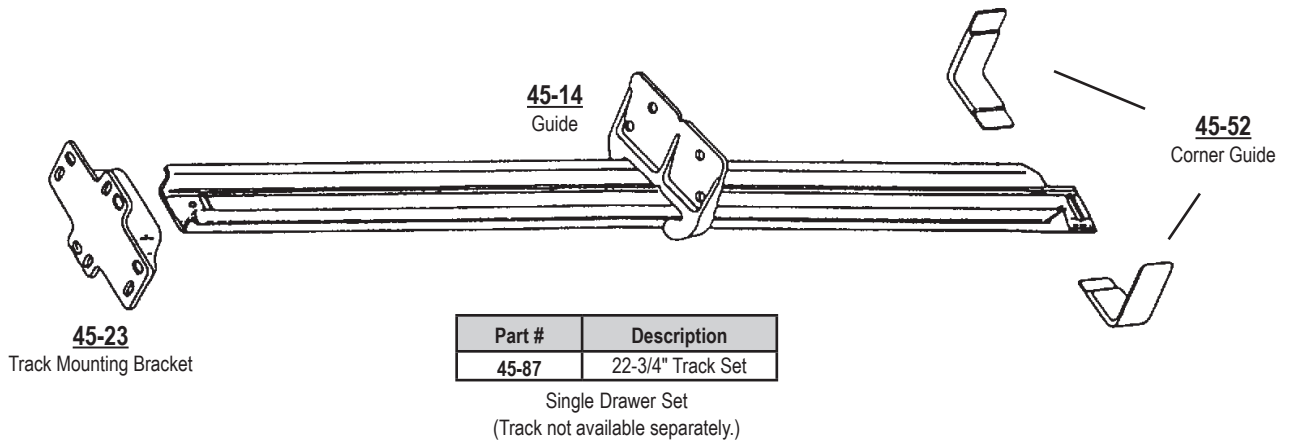
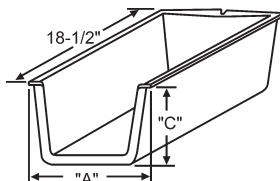

Part#	"A"	"C"	# Stamped on part	Carton Qty.
45-89	14-5/8"	4"	TP-154	8
45-90	20-1/2"	4"	214-24	8
45-91	11-3/4"	4"	TP-124	16
45-92	17-1/2"	8"	TP-188	10
45-93	17-1/2"	4"	TP-184	10
45-94	8-3/4"	4"	TP-94	24
45-95	11-3/4"	8"	128-15	12

Replace old worn out cabinet drawers with plastic drawer inserts. Also replaces Old Style Triangle Pacific  
A packing fee will be assessed on orders with less than carton quantity.

## MONORAIL

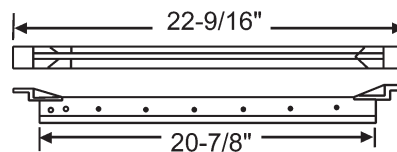

45-96

## DRAWER GUIDE

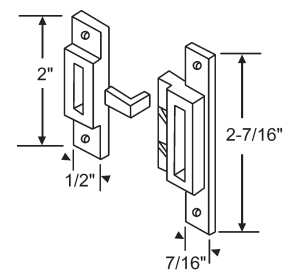

45-48

Front and Rear guide set for 45-96 monorail and drawer inserts.

## DRAWER GUIDES AND BRACKETS

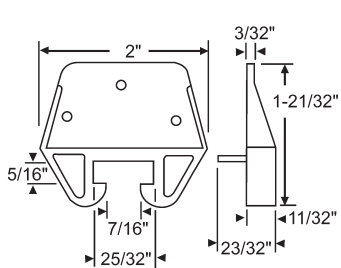

**45-1**  
Drawer guide  
Old KD-01

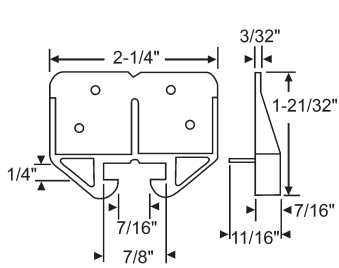

**45-15**  
Drawer guide

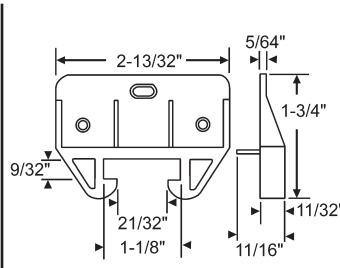

**45-6**  
Drawer guide  
Old KD-06

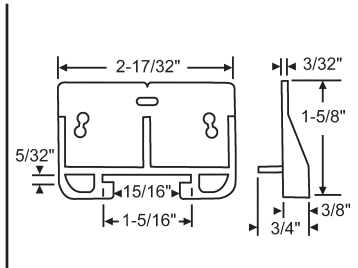

**45-14**  
Drawer guide  
Old KD-14

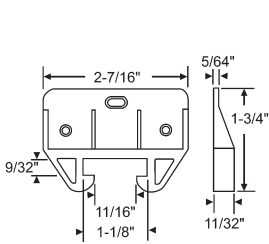

**45-7**  
Drawer guide  
Old KD-07

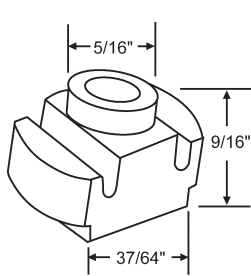

**900-9936**  
Drawer guide

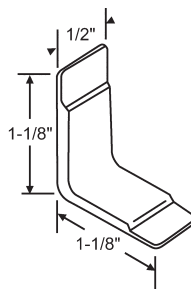

**45-52**  
Drawer Guide  
Nylon

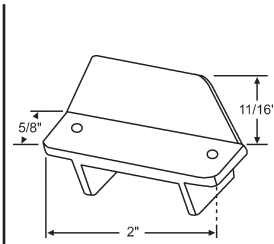

**45-10**  
Drawer Guide

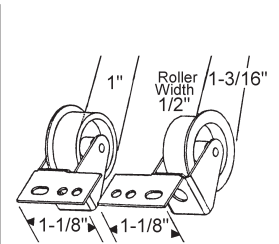

Part #	Hand
900-11808LH	LH
900-11808RH	RH

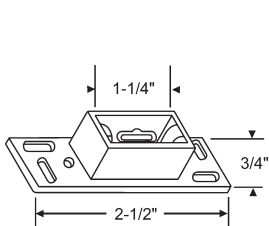

**45-9**  
Drawer Mounting Bracket

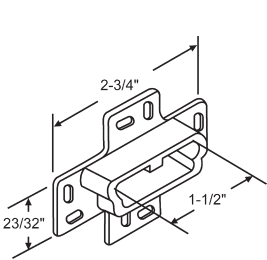

**45-23**  
Drawer Mounting Bracket

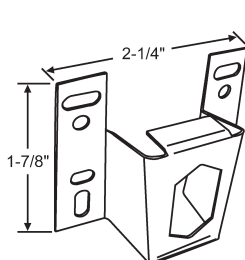

**900-11843**

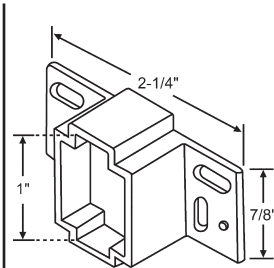

**45-16**  
Drawer Bracket

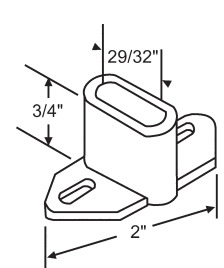

**45-26**  
Drawer Bracket

### SOCKETS

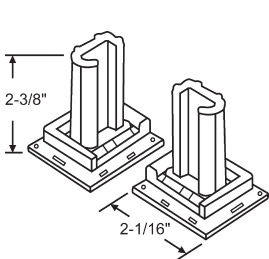

**45-203**  
Adjustable Rear Mount Drawer  
Slide Socket Set

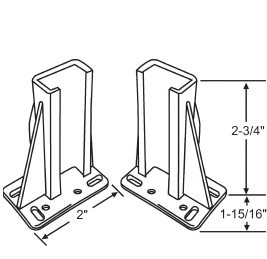

**45-229**  
Rear Mount Drawer  
Slide Socket Set

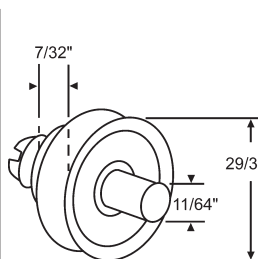

**45-98**  
Drawer Roller with Axle

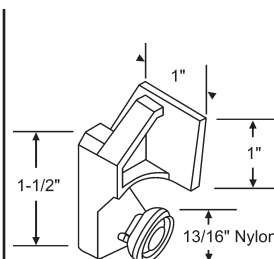

**45-19**  
Cabinet Roller  
**AJAX**

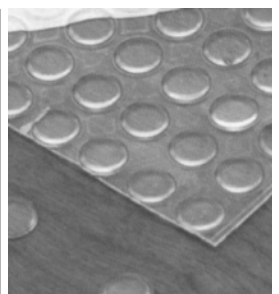

**45-240**  
Clear Plastic Bumper  
1/2" W x 1/16" H

## ROLLERS

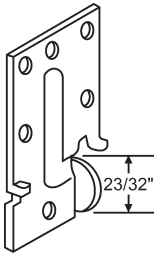

**900-17778**  
Roller Bracket  
**No Longer Available.**  
Use: 900-17778NS

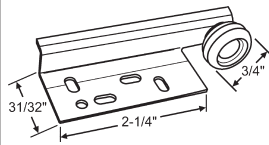

**900-17778NS**  
Roller Bracket. New Style

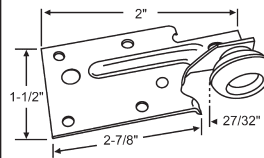

**45-24**  
Drawer Roller. Nylon Roller

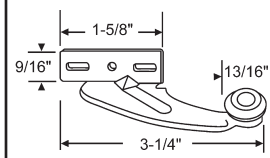

**45-18**

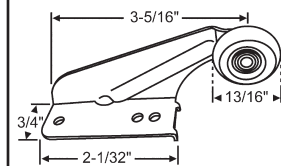

**45-17**

## HINGES

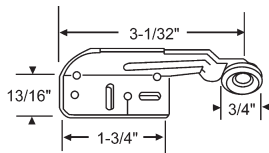

**45-25**

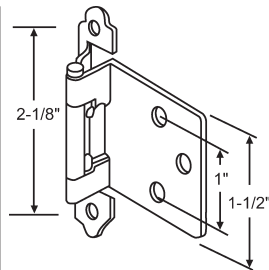

Part #	Finish
<b>900-8910AB</b>	Antique Brass

Pair with Screws and Pads

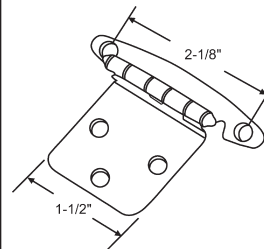

Part #	Finish
<b>45-235PB</b>	Polished Brass
<b>45-235AB</b>	Antique Brass

Flush Mount, Free Swinging Hinge

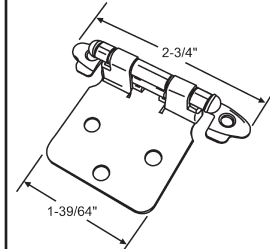

Part #	Finish
<b>45-236PB</b>	Polished Brass

Flush Mount Self-Closing Hinge

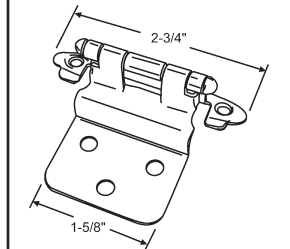

Part #	Finish
<b>45-237PB</b>	Polished Brass
<b>45-237AB</b>	Antique Brass

Offset Self-Closing Hinge

## MINI DOOR STRUTS

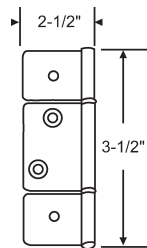

**8-356**  
Polished Brass 3 Leaf

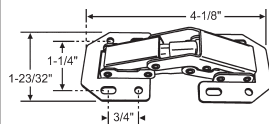

**45-225**  
Nickel Finish Self-Closing Hinge  
4 way Adjustable, 90° Opening

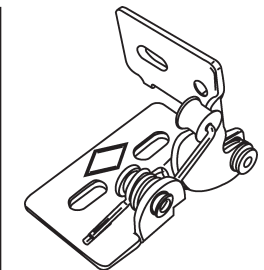

**45-230**  
Polished Chrome #5 Knife Hinge

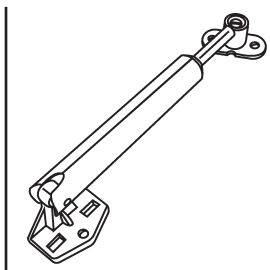

**45-208**  
Black Mini Door Strut, Nylon

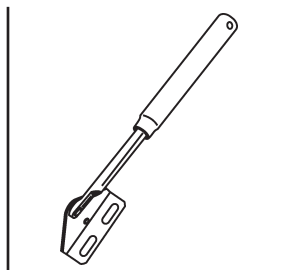

Part #	Finish
<b>45-207</b>	Satin Nickel
<b>45-206</b>	Antique English

Mini Door Strut, Steel

## CABINET SHELF SUPPORTS AND BRACKETS

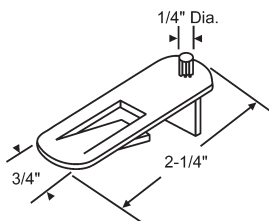

Part #	Finish
<b>45-101W</b>	White

For 1/2" Shelf

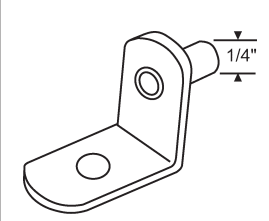

**900-10820**  
Shelf Support

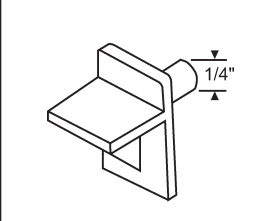

**45-99**  
Shelf Support  
Plastic

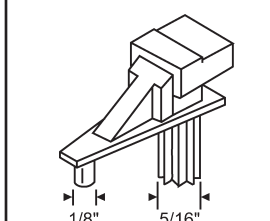

**45-100**  
Shelf Support

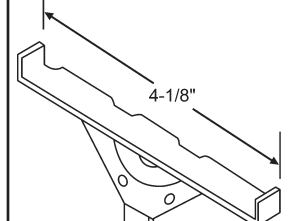

**900-9382**  
Medicine Cabinet Shelf Bracket

# CABINET HARDWARE

## LATCH AND CATCH

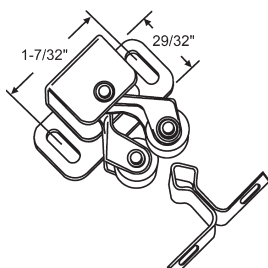

**45-216**

Heavy Duty Double Roller, RV  
Cabinet Catch. Antique Copper

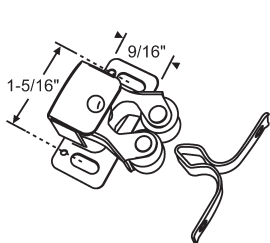

**900-6698**

Cabinet Catch  
Zinc Nickel Plated

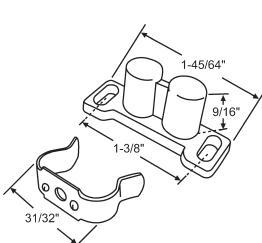

**900-10756**

Solid Plastic White Barrel Catch

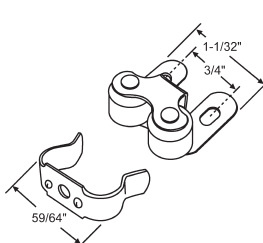

**900-9130**

Roller Catch  
Zinc Nickel Plated

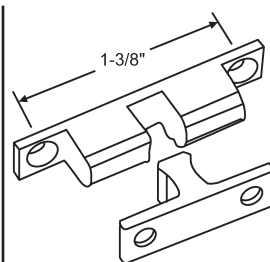

**45-227**

Solid Brass Ball Catch

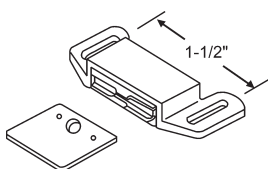

**900-6695**

Tan Plastic High Power Magnetic  
Catch with Flat Plate

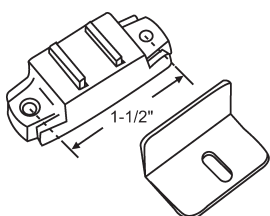

**900-11343**

Tan Plastic High Power Magnetic  
Catch with Angle Plate

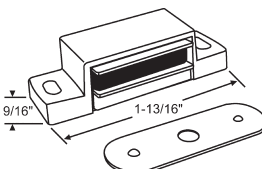

**45-194**

Brown Plastic Magnetic Cabinet  
Door Catch with Flat Plate

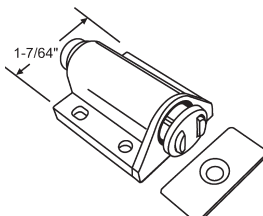

**45-239**

Black Magnetic Touch Latch

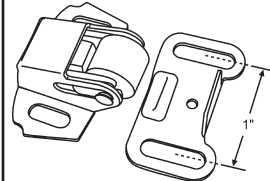

**45-130**

Roller Catch and Strike  
Zinc Nickel Plated

## HANDLES AND KNOBS

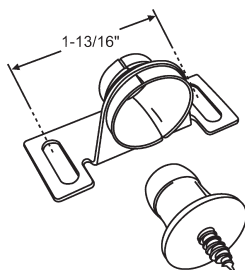

**45-245**

Black Self Aligning Catch

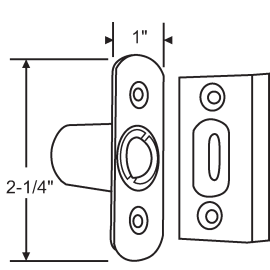

**900-10858R**

Ball Catch and Strike  
with Rounded Corners  
Brass Plated

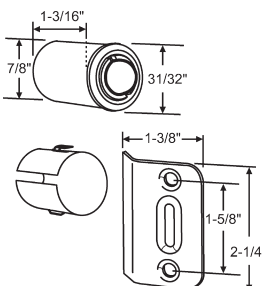

**900-10858DI**

Dive In Bullet Ball Catch with  
Adjustable Tension Ball.  
Brass Plated



**8-471**

1-1/8" Knob  
Polished Brass



**8-470**

1-1/4" Knob  
Polished Brass

## ROSETTE



**8-482**

1-1/4" Knob  
Satin Nickel Finish

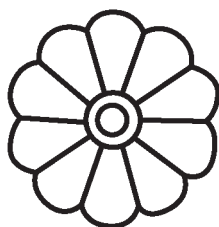

**900-20751**

White with Screws

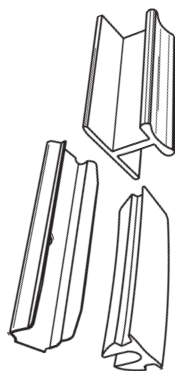

**8-373**

Hardware Kit

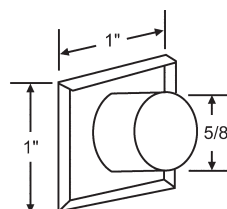

**900-16236**

Mirror Pull  
Acrylic

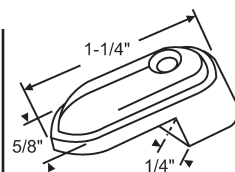

**900-13119**

Teardrop Mirror Clip with Screws

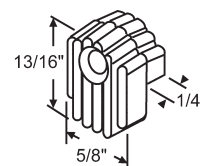

**900-9137**

Ribbed Mirror Clip  
without Screws